

5SVX15F030PT04QBE | Configuration Summary

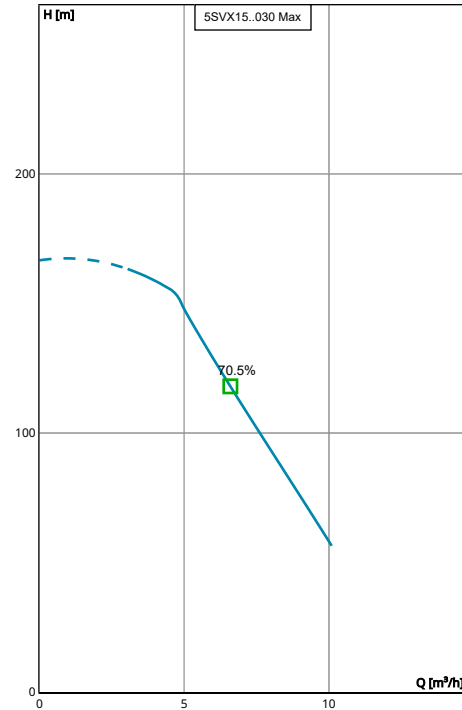

Take the efficiency and low lifetime costs of e-SV multistage pumps to new levels with hydrovar® X – first-class pump management that optimises connectivity, sustainability and performance. Hydrovar® X brings the best energy efficiency performances with its frequency converter coupled with the ultimate synchronous motor, manufactured by Xylem integrating decades of expertise and know-how in pumping solutions.



Performance according to ISO 9906:2012

PUMP

Installation	Pump Size
Complete Pump	5SV
Hydrovar Name	
hydrovar X+	

MATERIALS

Pump Body Material	Impeller Material
Stainless Steel (AISI 304)	Stainless Steel (AISI 304)

SEAL

Type of Seal	Rotating Face
Mechanical Seals	Silicon Carbide
Name	Stationary Face
Q1BEGG	Resin Impregnated Carbon
	Elastomers
	EPDM
	Springs
	AISI 316
	Metal Components
	AISI 316
	Min Temperature
	-30.0 °C
	Max Temperature
	120.0 °C

STANDARD OPTIONS

Special Configuration
Please Select

MOTOR

Poles	Power
2	3 kW
	Phase (~)
	3
	Voltage
	380-480 V

FLANGE

Flange
[F] = Round Flanges (AISI 304)

VFD

Phase	Supply Voltage
3	380-480 V

5SVX15F030PT04QBE | Product Details

SV F-N



05920_B_DS

Construction Materials

Pump body (1) Stainless steel / AISI 304	Shaft (5) Stainless steel / AISI 304	Seal housing (9) Stainless steel / AISI 304	Shaft sleeve and bushing (13) Tungsten carbide
Impeller (2) Stainless steel / AISI 304	Adapter (6) Cast Iron / ASTM Class 35	Mechanical seal (10) See Seal section	Fill / Drain plugs (14) Stainless steel / AISI 304
Diffuser (3) Stainless steel / AISI 304	Base (7) Aluminium	Elastomers (11) See Seal section	Tie rods (15) Galvanized steel
Outer sleeve (4) Stainless steel / AISI 304	Coupling (8) Aluminium	Coupling protection (12) Stainless steel / AISI 304	Wear ring (16) Technopolymer PPS

Motor

Motor Name EXM100B14SV/4.030B	Rated power 3 kW	Enclosure IP 55	ICL F
Phase 3	IE Class IE5	Frame Size 100	Standard IEC
Voltage 380-480 V	Motor Vendor Xylem		
Speed 3600.0 rpm			
Rated Current 6.74 A			

5SVX15F030PT04QBE | Hydraulic Data & Performance Curve

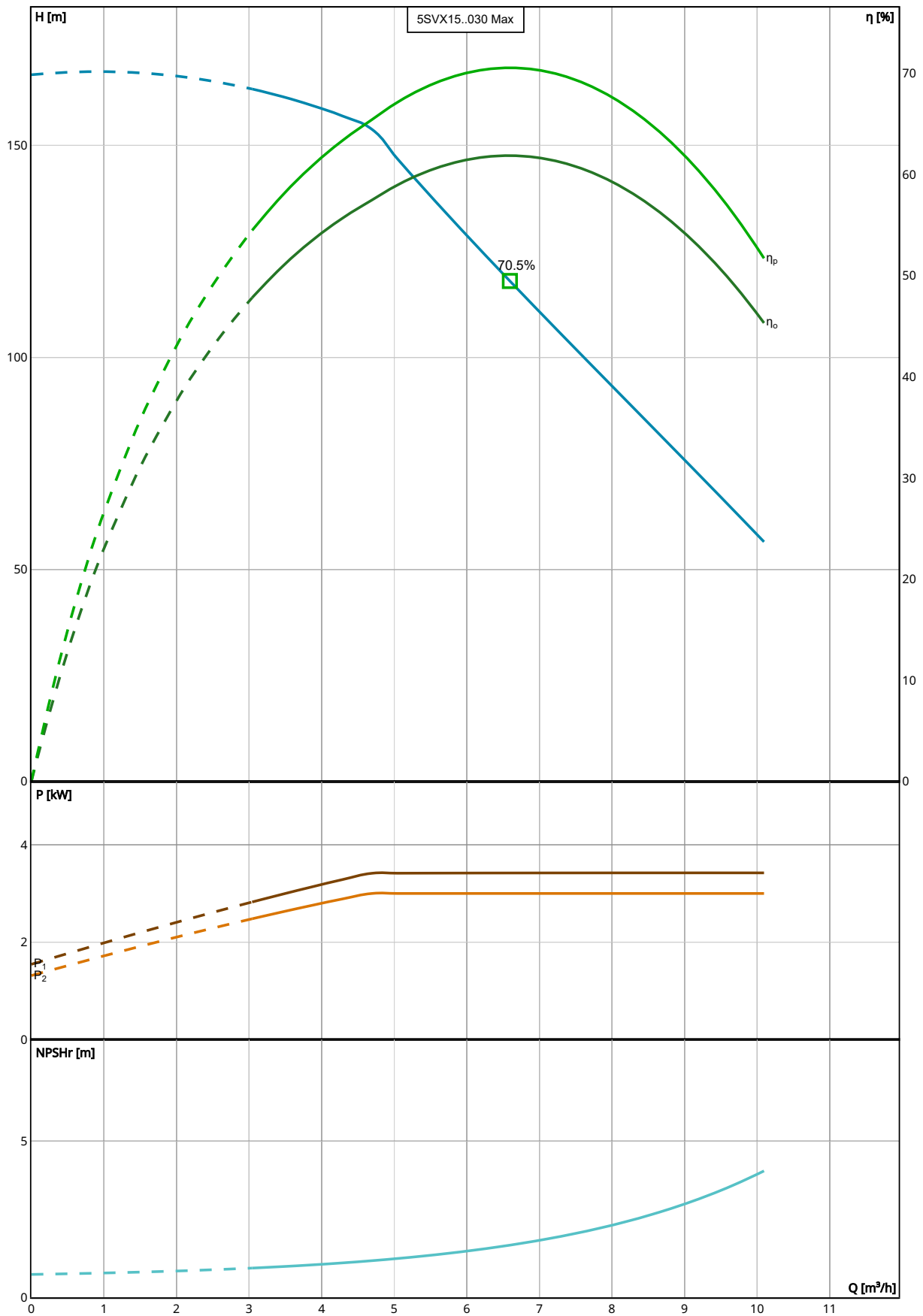

Performance according to ISO 9906:2012

Selection

Series	Standby Pumps
e-SV hydrovar X	No Standby Pump
Name	
5SVX15..030	
Stages	
15	
Frequency	
50 Hz	
Acceptance Grade	
Manufacturer's Standard	
System Type	
Single Pump	
Operating Pumps	
1	

Fluid and Operating Conditions

Fluid Type	Density
Water	1,000 kg/m ³
Fluid Temperature	Dynamic Viscosity
4 °C	0.002 Pa·s
Specific Gravity	Fluid Vapor Pressure
1	8.14 mbar
	Atmospheric Pressure
	1,013.53 mbar
	Elevation
	0 m
	Ambient Temperature
	20 °C
	NPSH Available
	10.27 m
	Submergence
	0 m

Design Curve

Rated Speed	BEP
3,600 RPM	70.54 %
Min Flow	BEP Flow
3.04 m ³ /h	6.59 m ³ /h
Max Flow	BEP Head
10.09 m ³ /h	118.03 m
H@QMin	Max Operating Pressure
163.3 m	16,391.56 mbar
H@QMax	Max P2
56.52 m	3.01 kW

5SVX15F030PT04QBE | Dimensional Data & Drawing

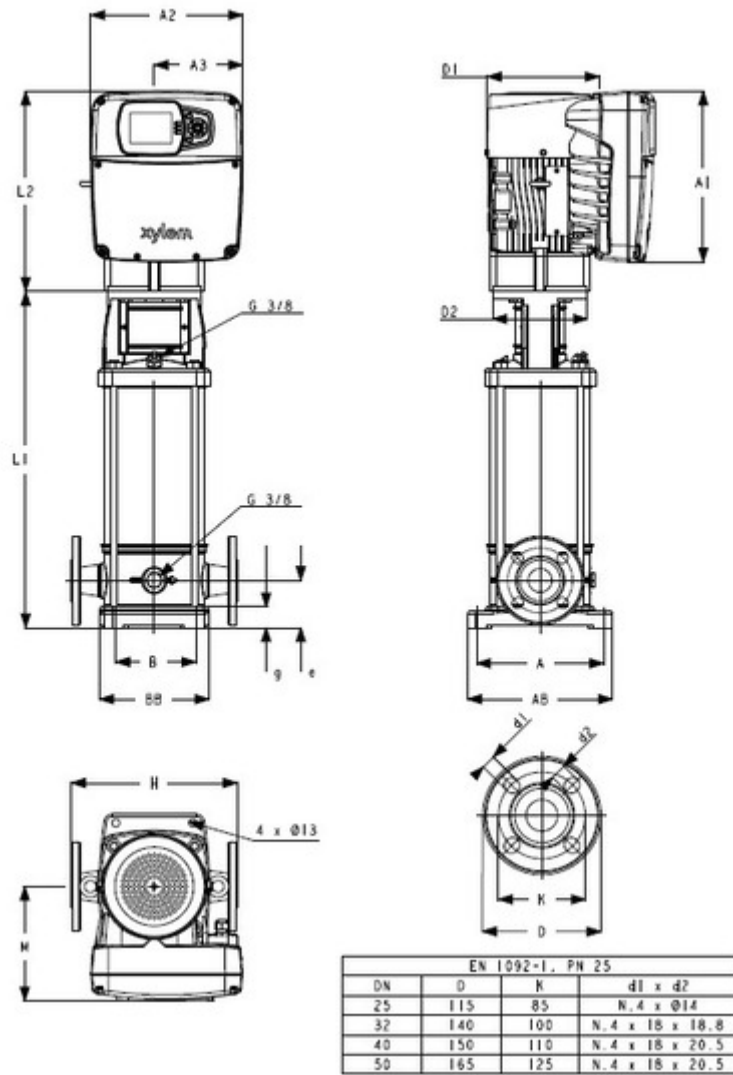

Drawing is preliminary and is subject to change.

Dimensions

A 180 mm	D2 160 mm	L1 623 mm	L2 339 mm
AB 210 mm	e 75 mm	DN 32 mm	D1 179 mm
B 100 mm	g 25 mm	Weight (Pump) 15.8 kg	A1 289 mm
BB 150 mm	H 250 mm	Total Weight 40.28 kg	A2 256 mm
A3 149 mm			
M 194 mm			