

22SVE02F015P0M/2 | Configuration Summary

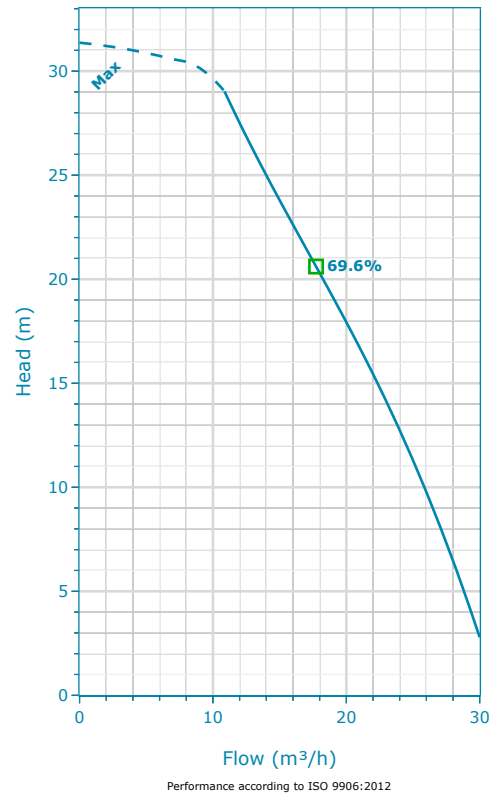

The SVE pump is a non-self priming vertical multistage pump coupled with eSM drive. The pump casing is available with different configurations and connection types.



PUMP

Installation
Complete Pump

MATERIALS

Pump Body Material Stainless Steel (AISI 304)	Impeller Material Stainless Steel (AISI 304)
---	--

SEAL

Type of Seal Mechanical Seals	Rotating Face Silicon Carbide
Name Q1BEGG	Stationary Face Resin Impregnated Carbon
	Elastomers EPDM
	Springs AISI 316
	Metal Components AISI 316
	Min Temperature -30.0 °C
	Max Temperature 120.0 °C

MOTOR

Poles 2	Power 1.5 kW
	Phase (~) 1
	Voltage 208-240 V

FLANGE

Flange
[F] = Round Flanges (AISI 304)

22SVE02F015P0M/2 | Product Details

SV F-N

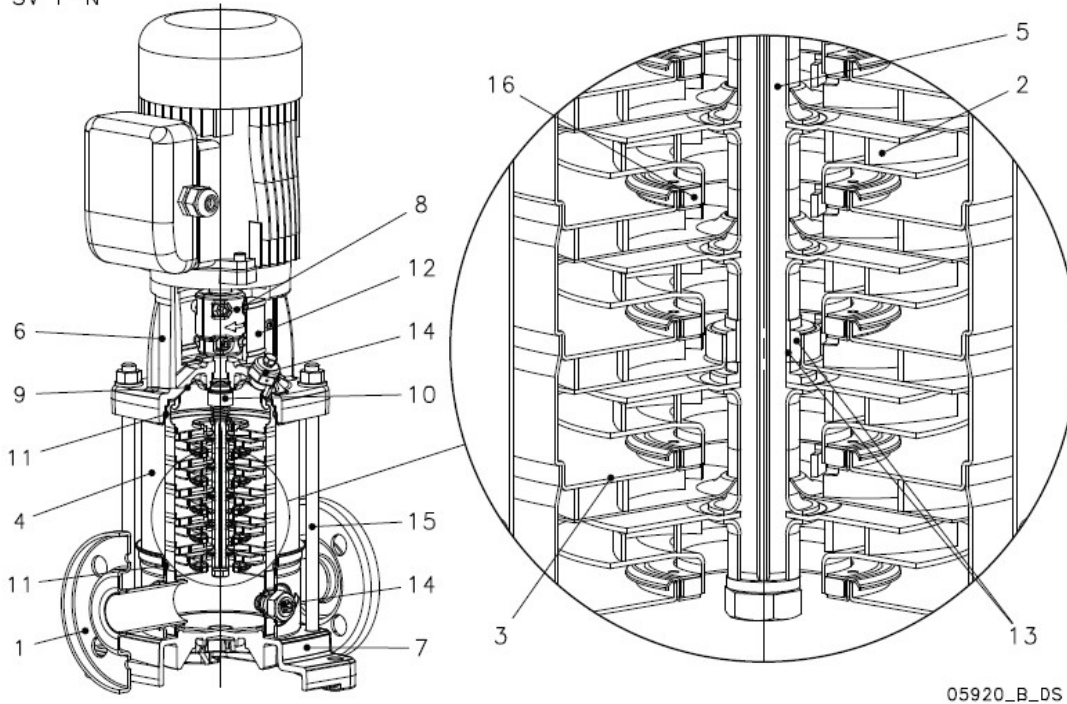

05920_B_DS

Construction Materials

Pump body (1) Stainless steel / AISI 304	Shaft (5) Stainless steel / AISI 304	Seal housing (9) Stainless steel / AISI 304	Shaft sleeve and bushing (13) Tungsten carbide
Impeller (2) Stainless steel / AISI 304	Adapter (6) Cast Iron / ASTM Class 35	Mechanical seal (10) See Seal section	Fill / Drain plugs (14) Stainless steel / AISI 304
Diffuser (3) Stainless steel / AISI 304	Base (7) Aluminium	Elastomers (11) See Seal section	Tie rods (15) Galvanized steel
Outer sleeve (4) Stainless steel / AISI 304	Coupling (8) Aluminium	Coupling protection (12) Stainless steel / AISI 304	Wear ring (16) Technopolymer PPS

Motor

Motor Name ESM90R/115 SVE	Phase 1	Enclosure IP 55	ICL F
Design e-SM Motor	Rated power 1.5 kW	Frame Size 90R	Standard IEC
Service Factor 1	Rated Current 8.42-7.25 A		
Voltage 208-240 V	Motor Vendor Lowara		
Speed 3600.0 rpm			

22SVE02F015P0M/2 | Hydraulic Data & Performance Curve

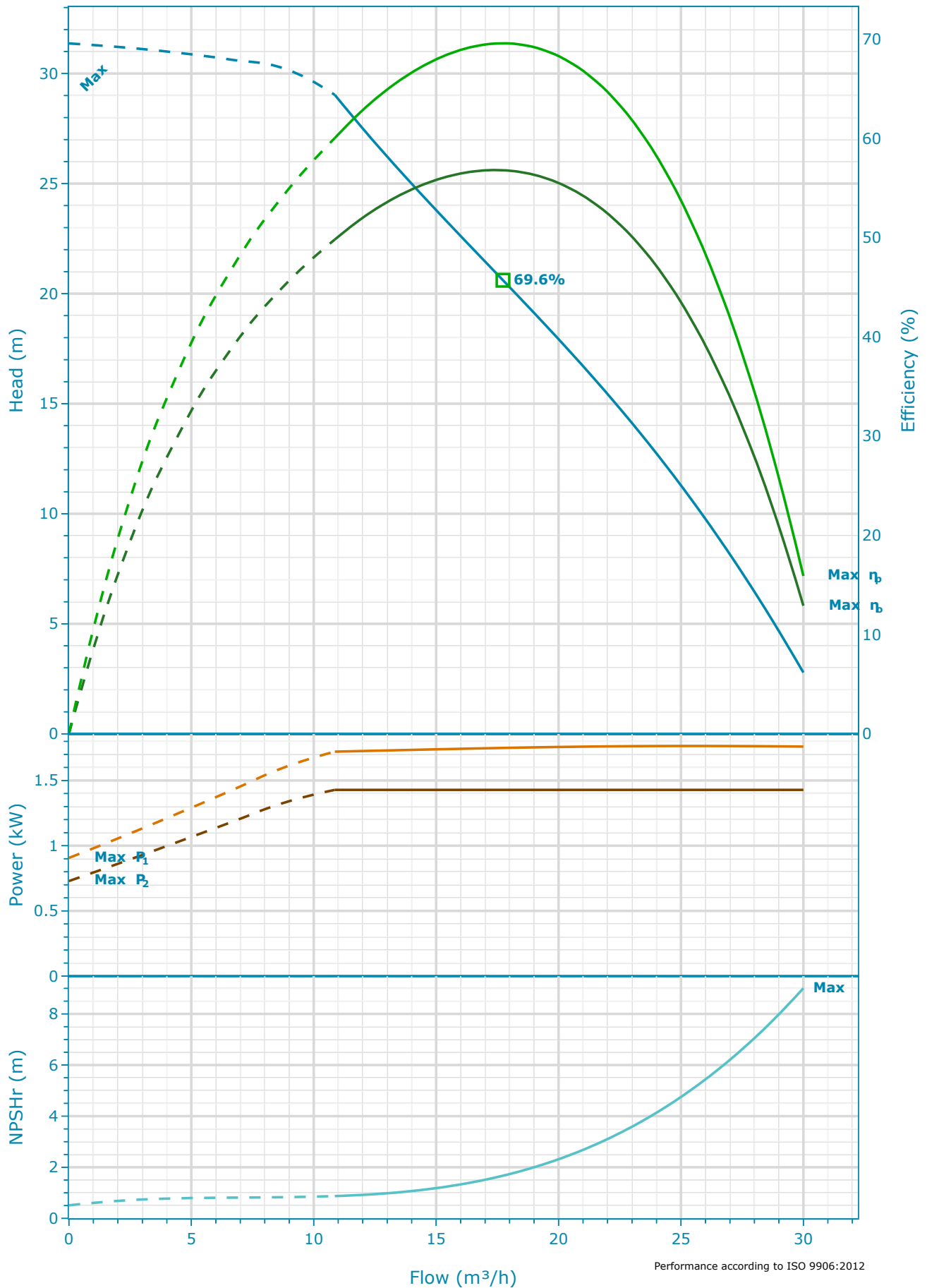

Selection

Series Standby Pumps
e-SVE No Standby Pump

Name
22SVE02..015

Stages
2

Frequency
50 Hz

Acceptance Grade
Manufacturer's Standard

System Type
Single Pump

Operating Pumps
1

Fluid and Operating Conditions

Fluid Type Density
Water 1,000 kg/m³

Fluid Temperature Dynamic Viscosity
4 °C 0.002 Pa·s

Specific Gravity Fluid Vapor Pressure
1 8.14 mbar

Atmospheric Pressure
1,013.53 mbar

Elevation
0 m

Ambient Temperature
20 °C

NPSH Available
10.27 m

Submergence
0 m

Design Curve

Rated Speed BEP
3,600 RPM 69.57 %

Min Flow BEP Flow
10.86 m³/h 17.73 m³/h

Max Flow BEP Head
30 m³/h 20.61 m

H@QMin Max Operating Pressure
29.03 m 3,071.62 mbar

H@QMax Max P2
2.79 m 1.43 kW

22SVE02F015P0M/2 | Dimensional Data & Drawing

10-15-22SVE (F-N)

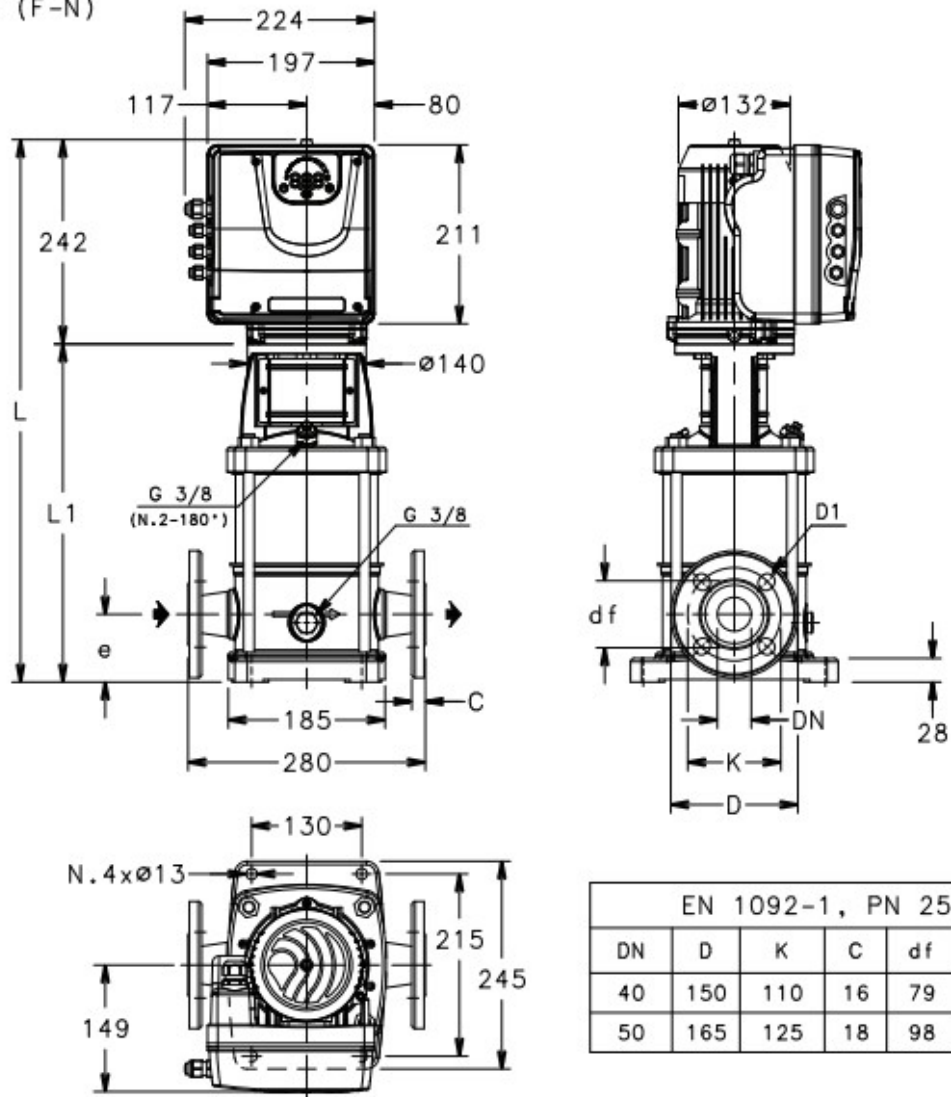

EN 1092-1, PN 25					
DN	D	K	C	df	D1
40	150	110	16	79	4x18
50	165	125	18	98	4x18

Drawing is preliminary and is subject to change.

Dimensions

D1	DN
4 x 18	50 mm
e	Weight (Pump)
90 mm	16.8 kg
L	Total Weight
661 mm	25.7 kg
L1	
419 mm	